

# Wireless Charging Pocket

VW Golf VII 2012>

241320-65-1



WIRELESS CHARGING

D

## EINBAUANLEITUNG

Schwierigkeitsgrad



GB

## INSTALLATION GUIDE

level of difficulty



A

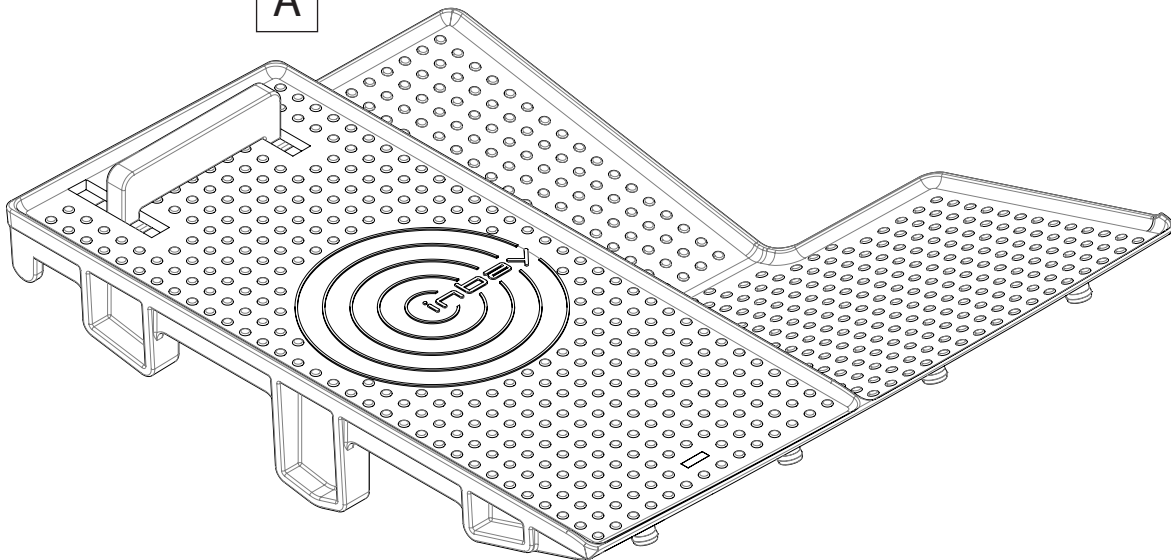

B

Seite: 2-10  
Page: 2-10

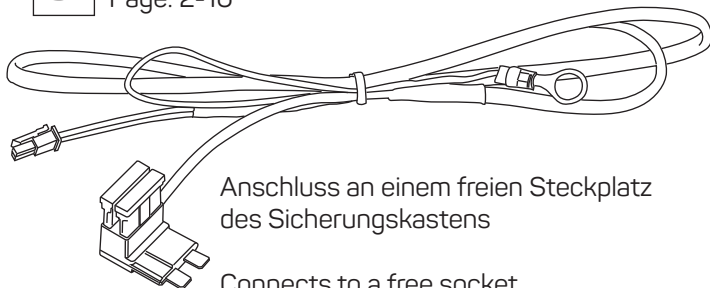

Anschluss an einem freien Steckplatz  
des Sicherungskastens

Connects to a free socket  
of the fuse holder box

C

Seite: 12-31  
Page: 12-31

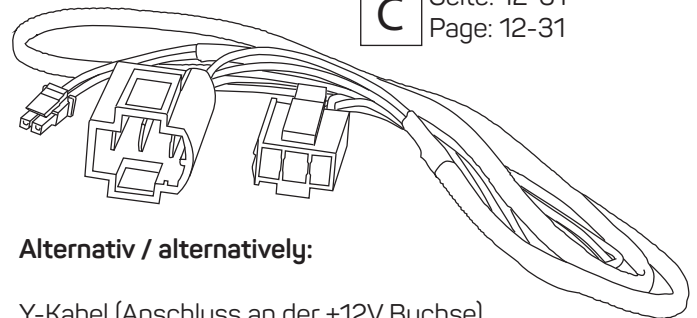

**Alternativ / alternatively:**

Y-Kabel (Anschluss an der +12V Buchse)  
Y-Cable (Connects to the +12V socket)

Sachgemäße Installation unter Beachtung dieser Einbauanleitung erforderlich. Achten Sie auf korrekte Anschlüsse. Verlegen Sie die Kabel so, dass Sie weder geknickt, gequetscht oder beschädigt werden können. Sorgen Sie dafür, dass sich die Kabel nicht in Gegenständen verfangen können.

Wir können keine Haftung für Schäden übernehmen, welche durch unsachgemäße Installation oder Nutzung verursacht wurden. Verwenden Sie darum ausschließlich das mitgelieferte Montagematerial.

Technische Änderungen vorbehalten, alle Angaben ohne Gewähr.

Das „Qi“ Logo ist Warenzeichen des „Wireless Power Consortium“

An appropriate installation in observance of these operating instructions is necessary. Please make sure the wiring is arranged so it is not bended or crimped due to the risk of cable break. Make sure that all connections are correct. Route the cable away from moving parts, do not allow the cable to be entangled, pinched or damaged in any way.

We will not be liable for damage due to improper installation or utilization. Use the specified accessory parts to prevent product failure.

Subject to technical modifications; no responsibility is accepted for the accuracy of this information.

The “Qi” symbol is a trademark of the “Wireless Power Consortium”





**ACHTUNG!**  
Die gelbe 20A Sicherung muss sich genau an dieser Position befinden !

**IMPORTANT!**  
The yellow 20A fuse has to be exactly in this position !

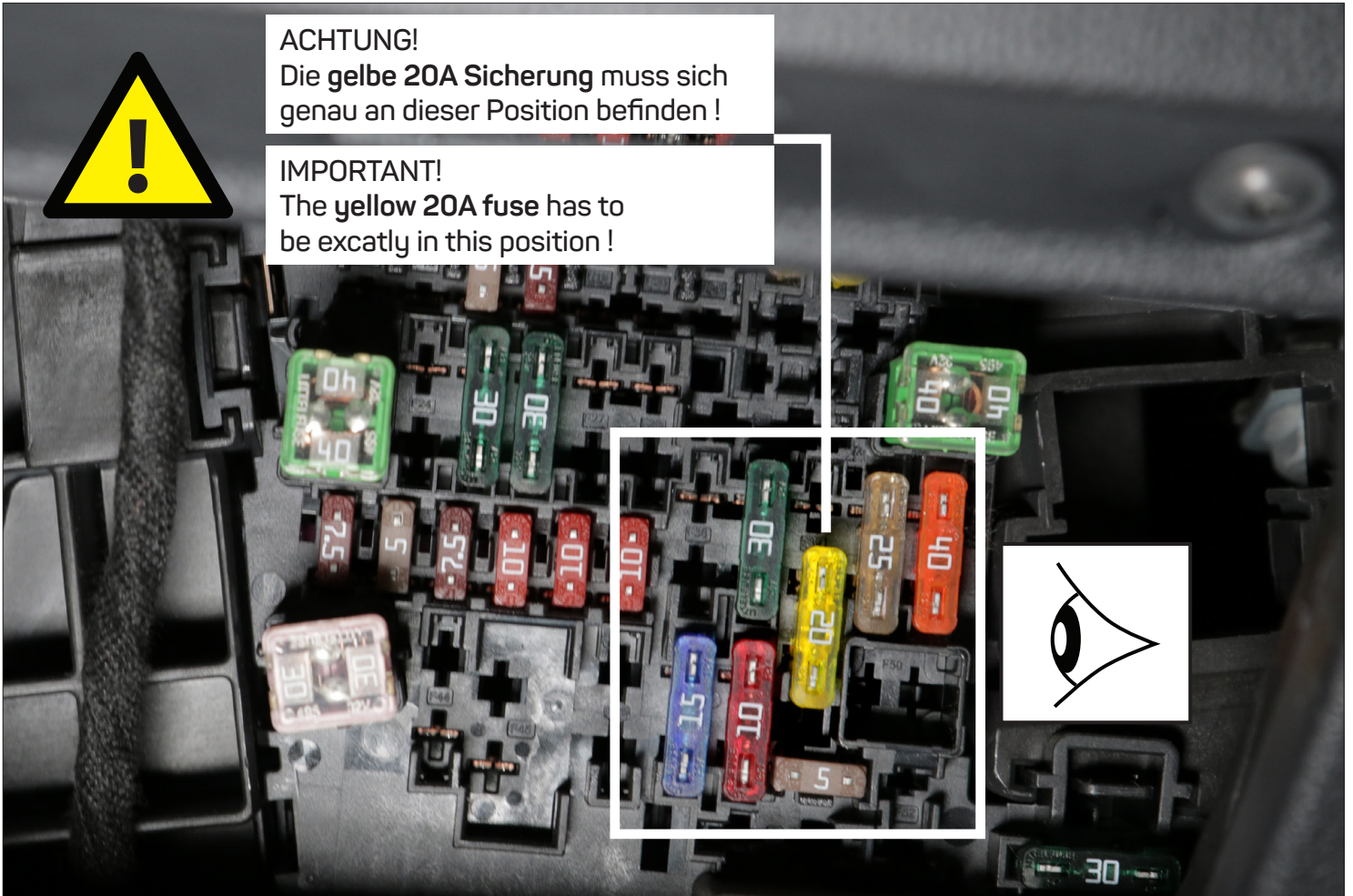

Falls sich die 20A Sicherung an einer anderen Position befinden sollte, stecken Sie diese um !

Switch the place of the 20A fuse if it is at this position !

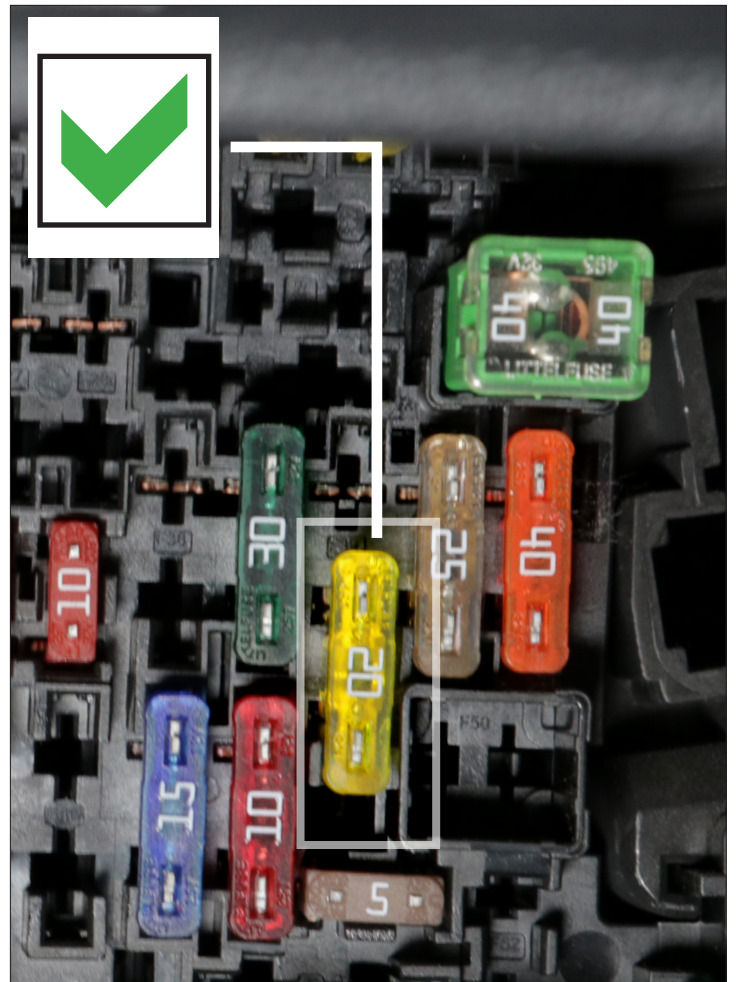

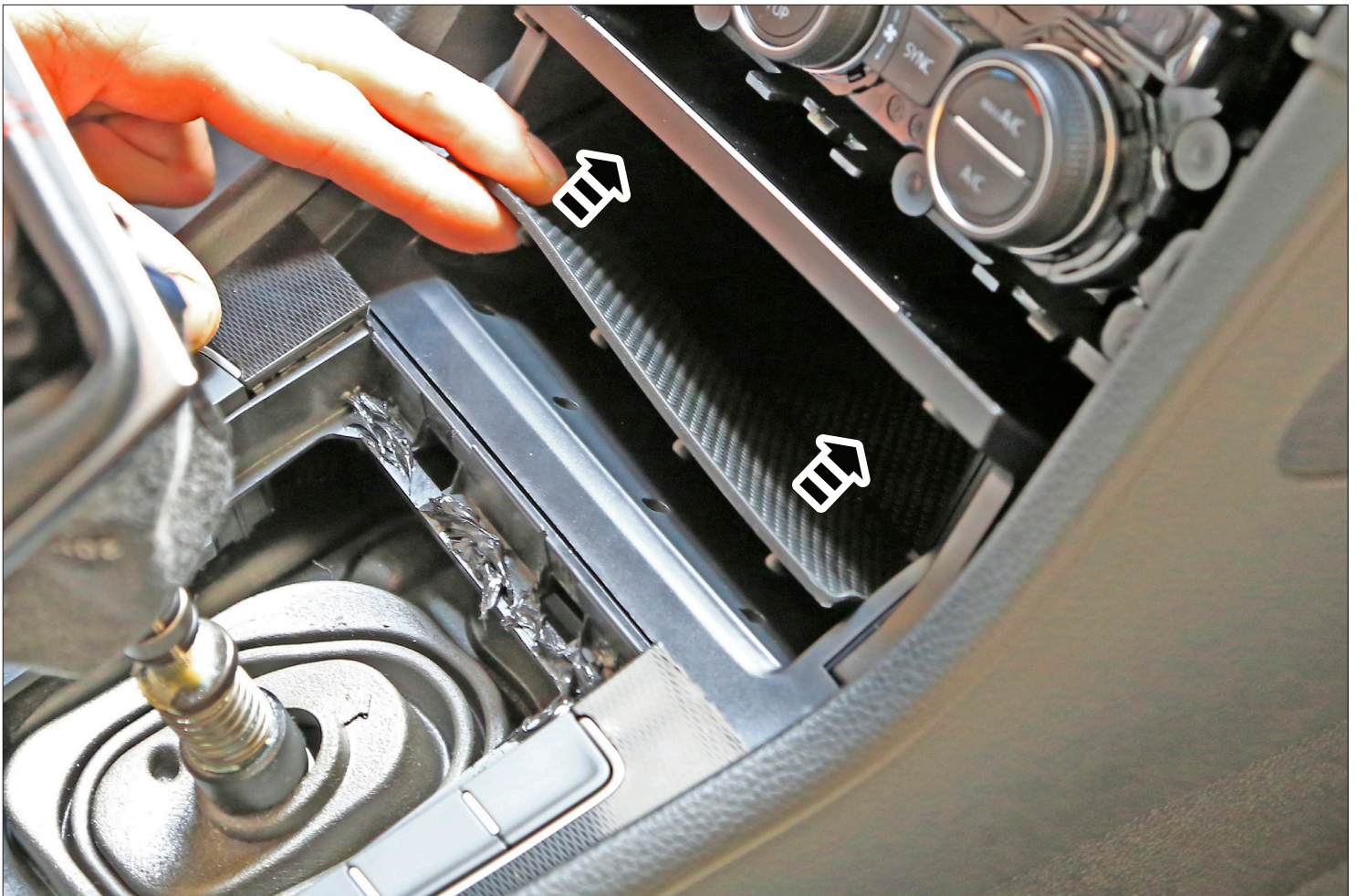
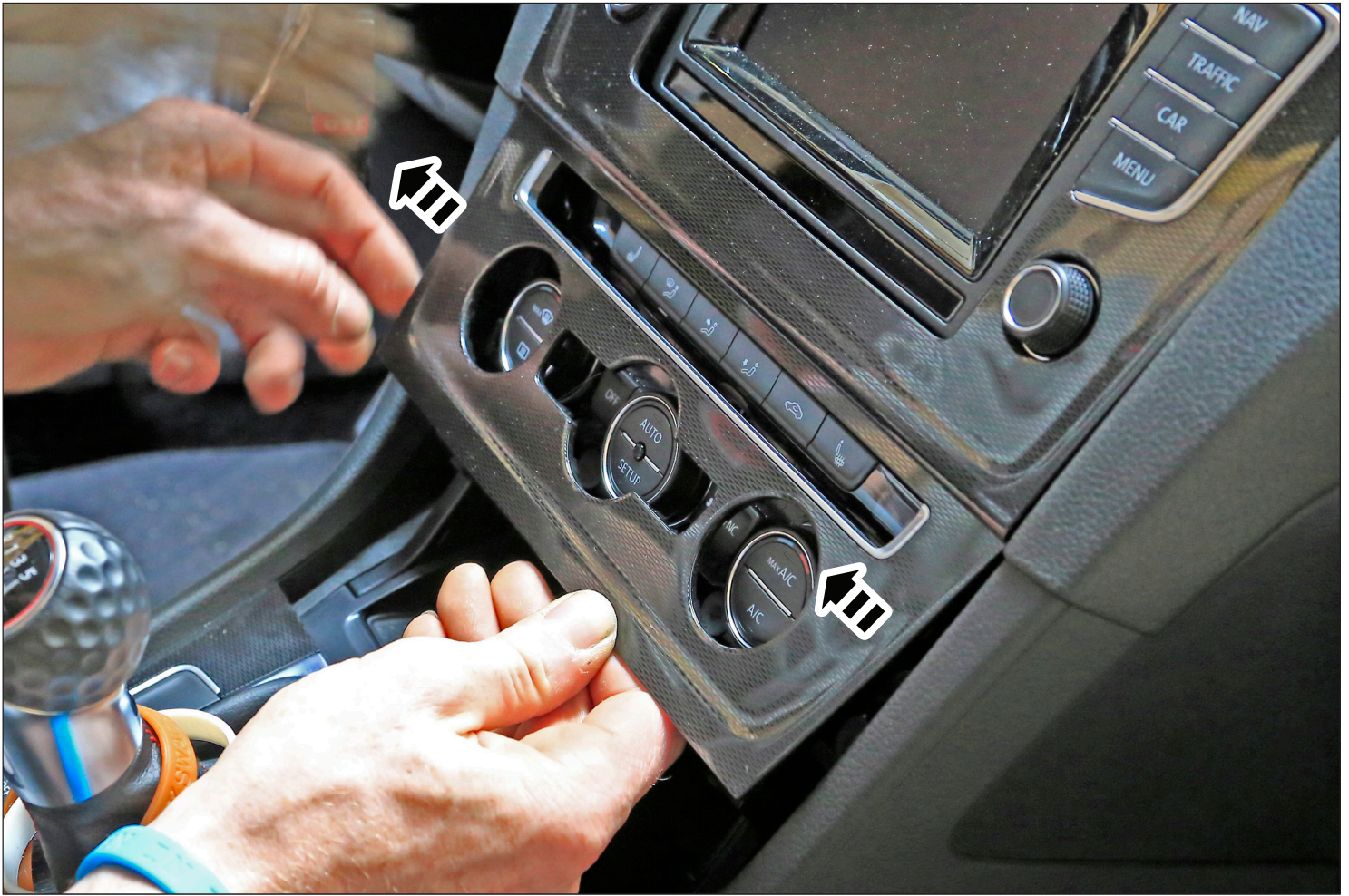

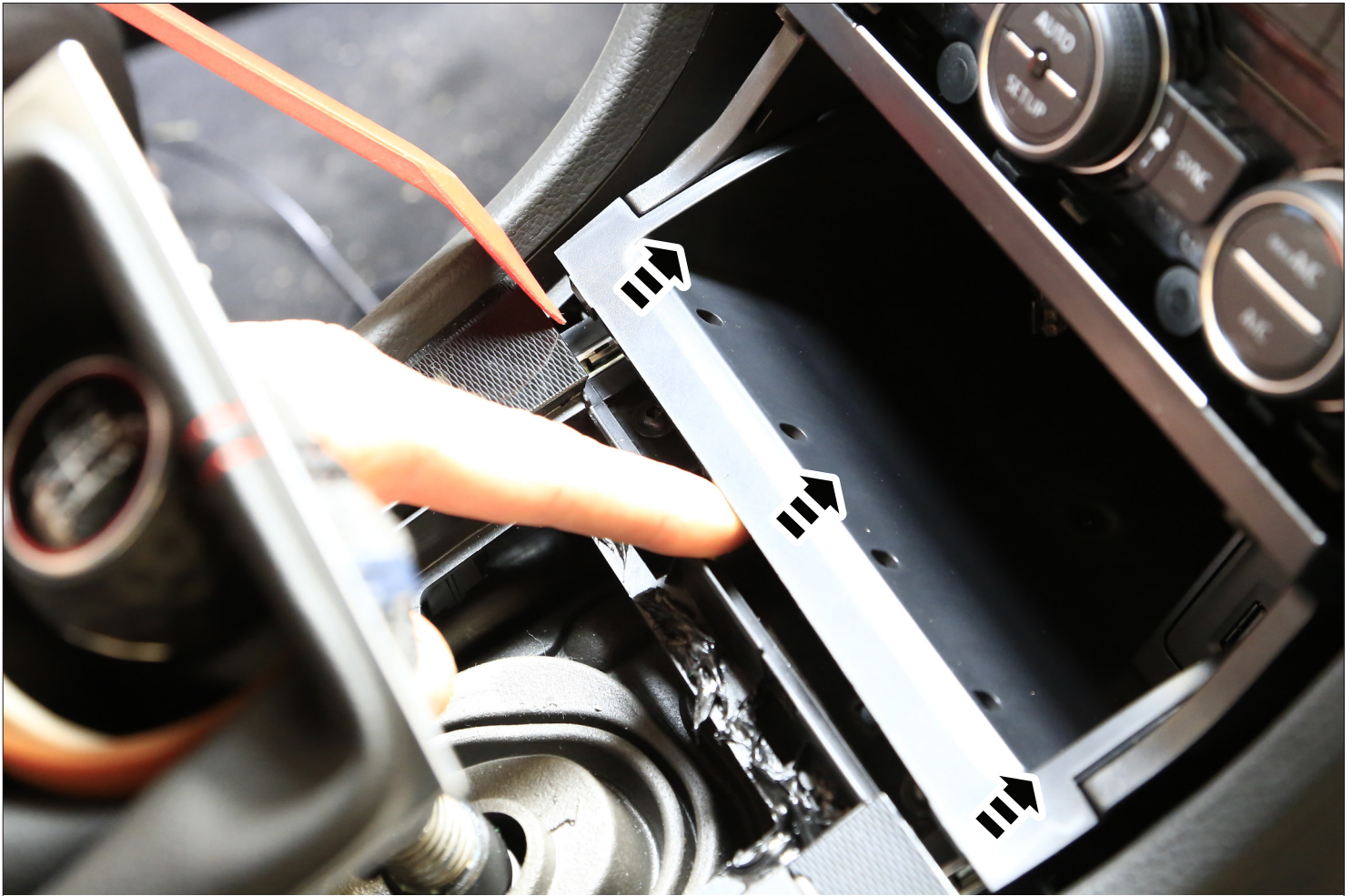

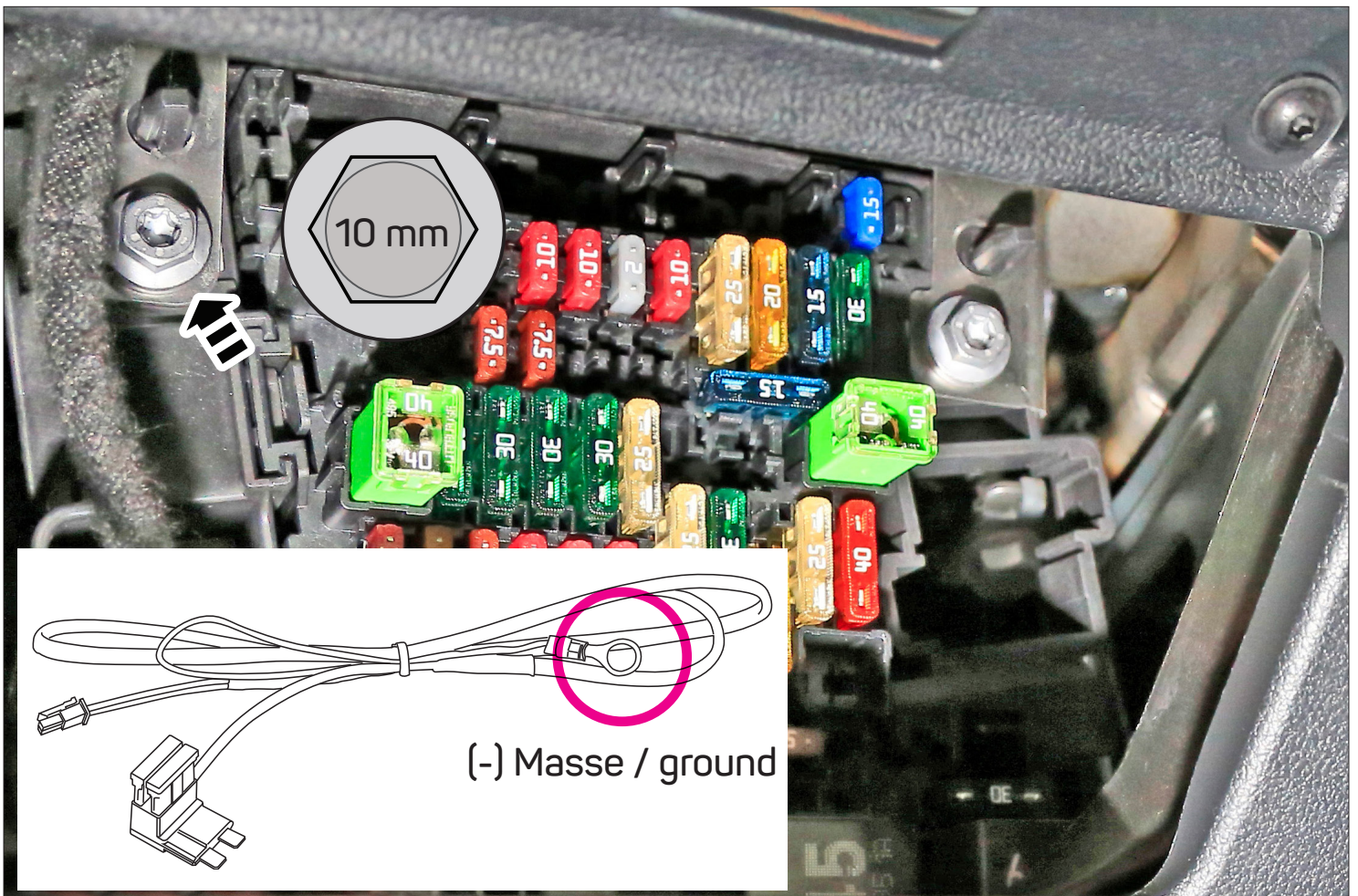
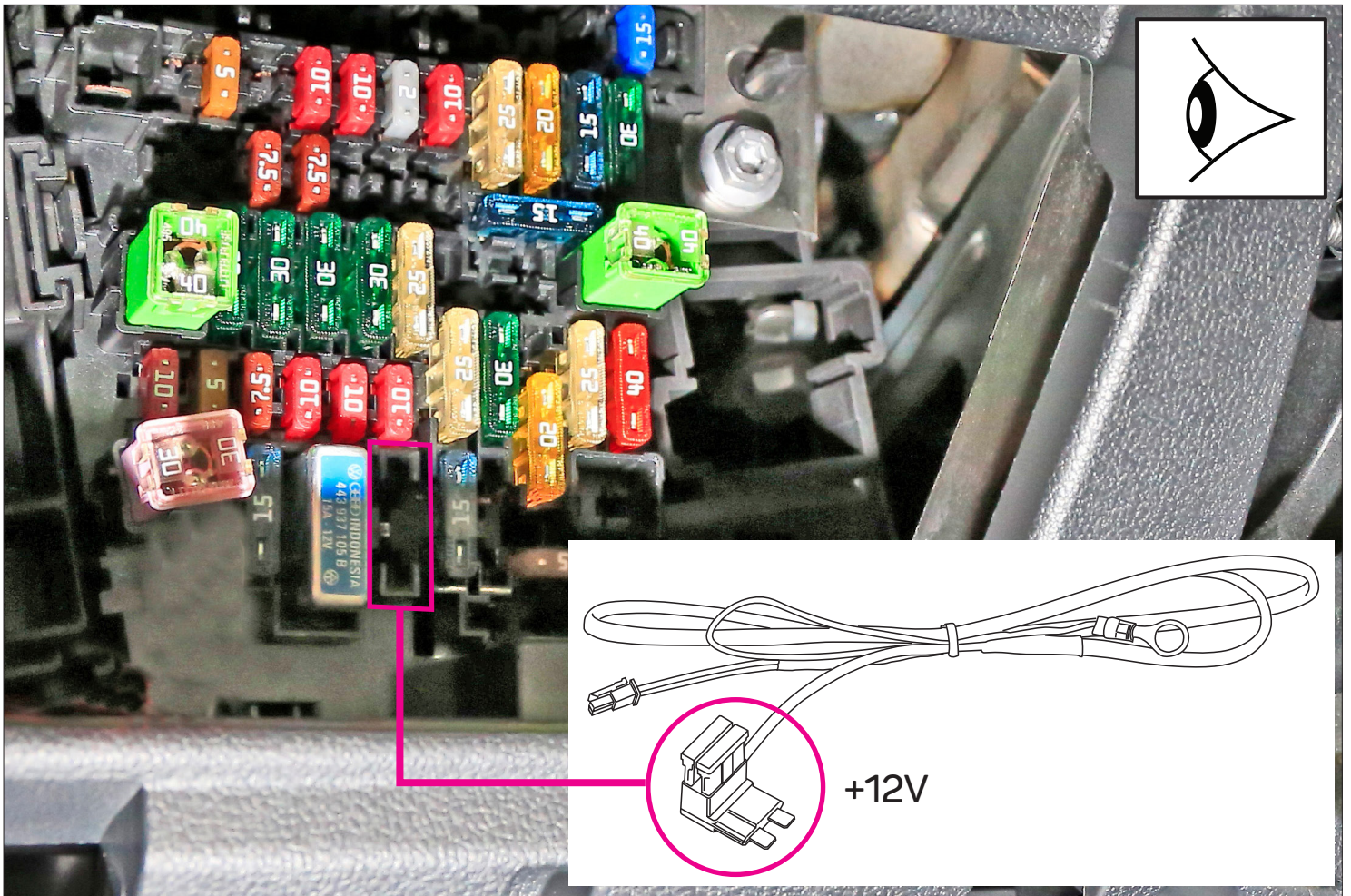



Ø ca. 10 mm



Ø ca. 10 mm

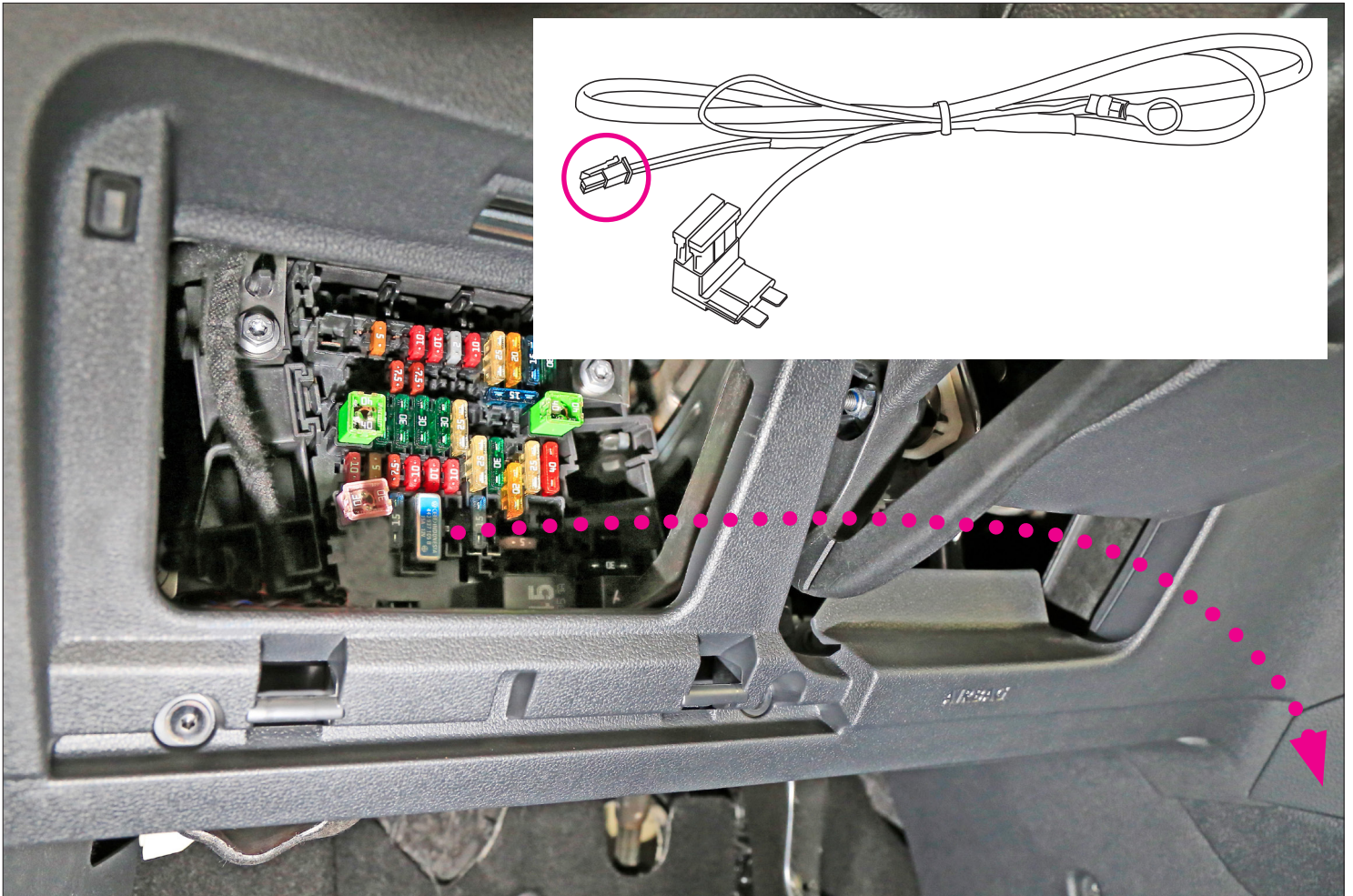



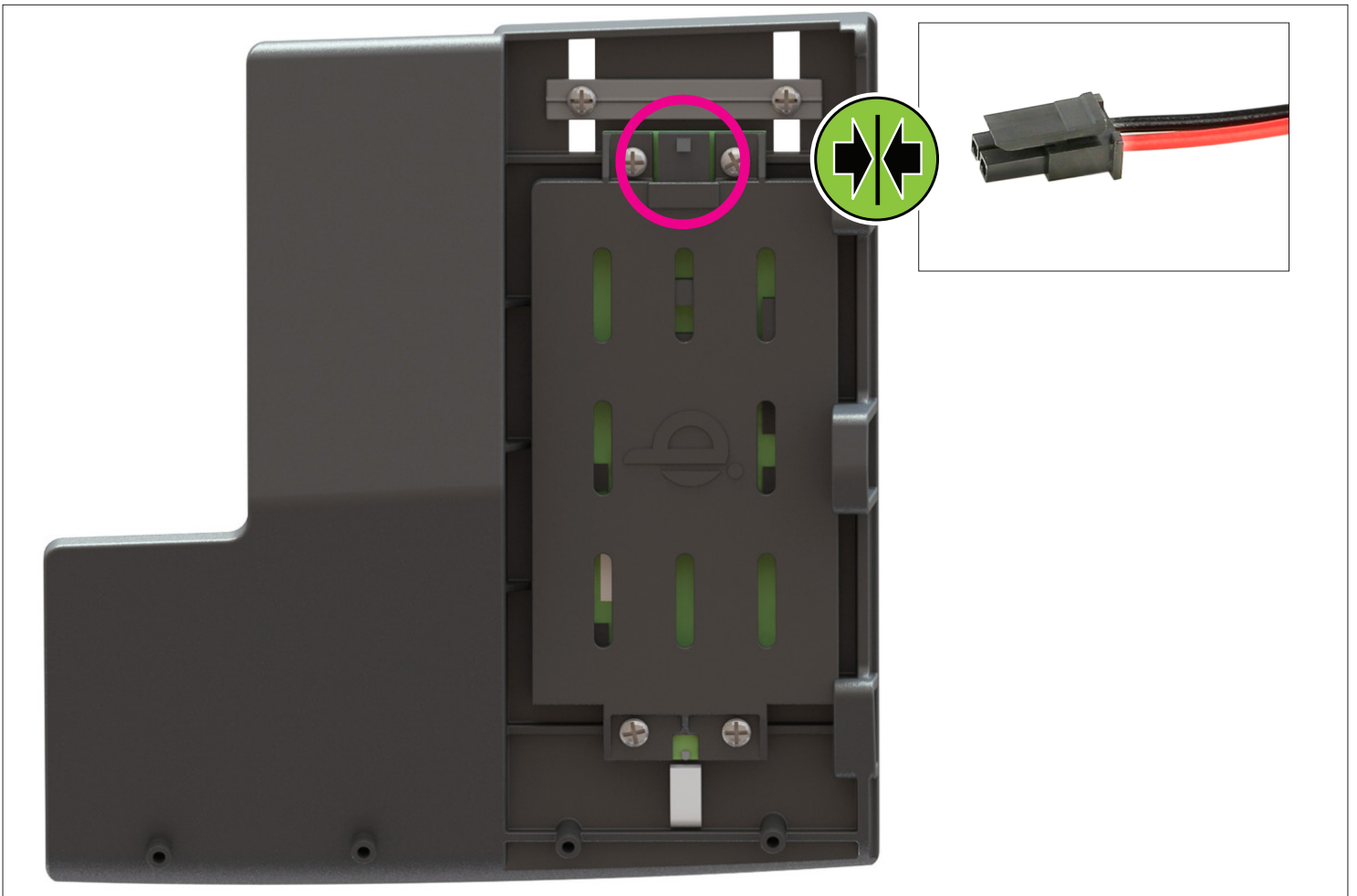
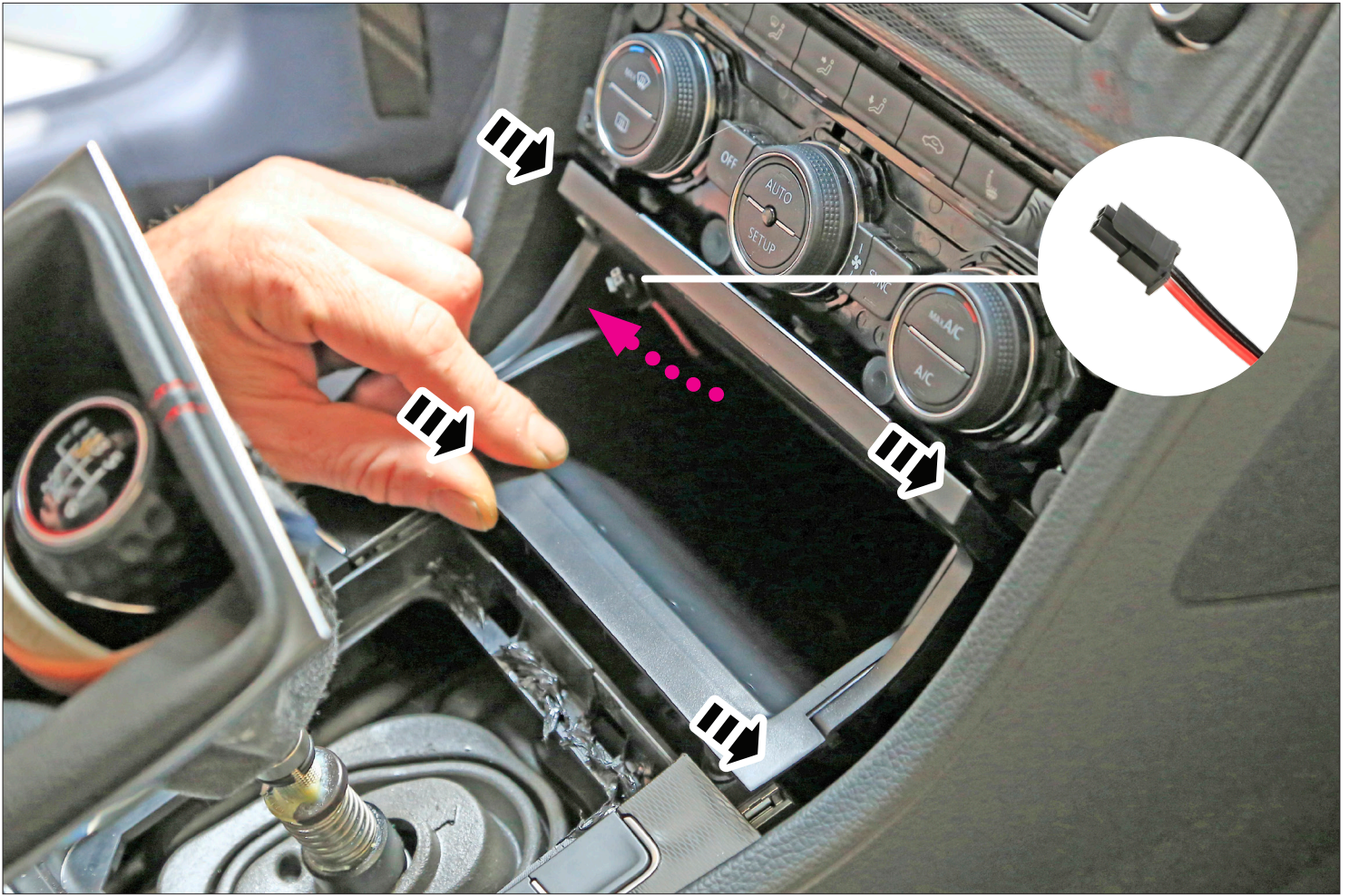

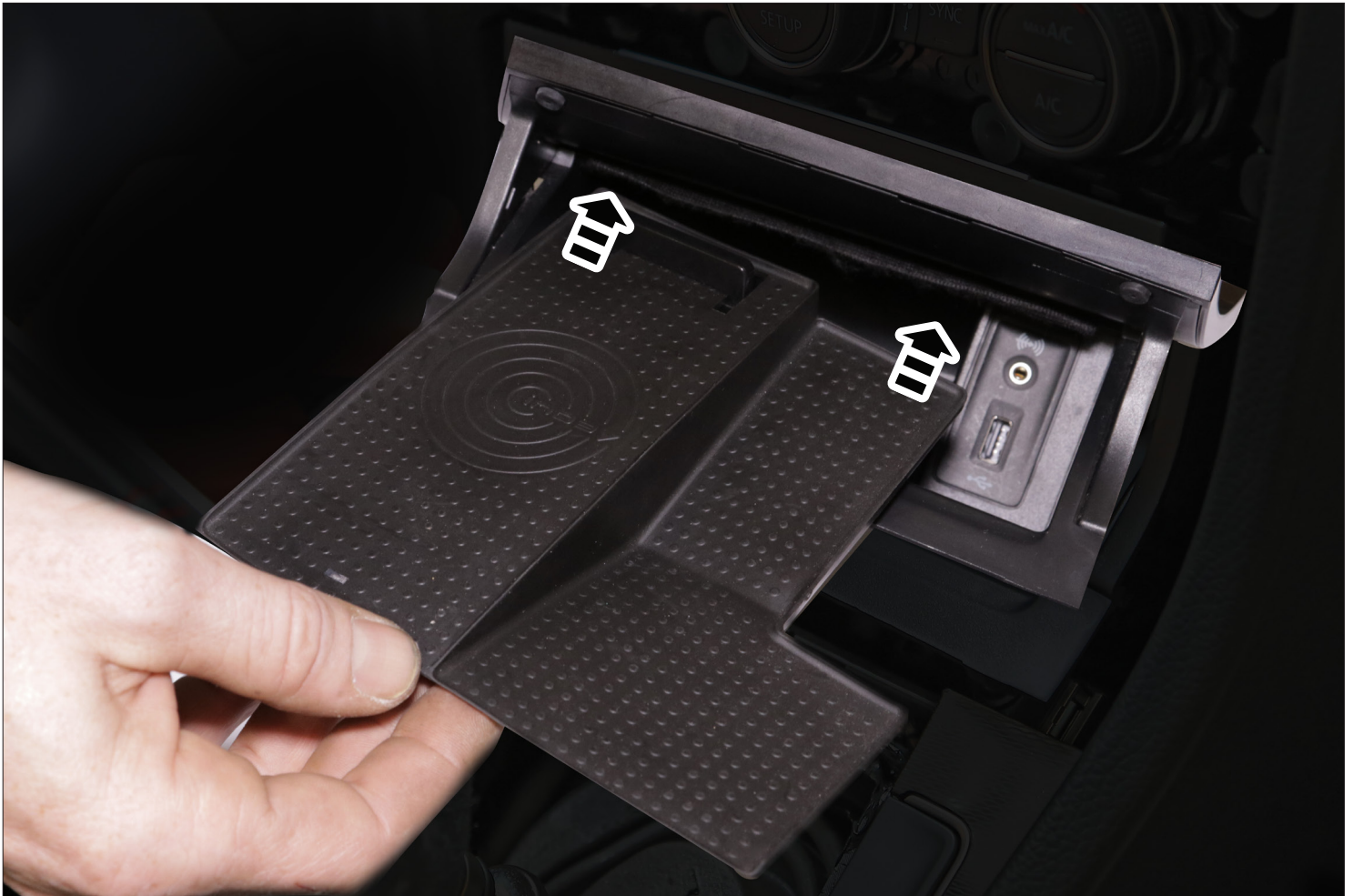

Blaue LED  
Blue LED



Rote LED  
Red LED









**ACHTUNG!**  
Die gelbe 20A Sicherung muss sich genau an dieser Position befinden !

**IMPORTANT!**  
The yellow 20A fuse has to be exactly in this position !

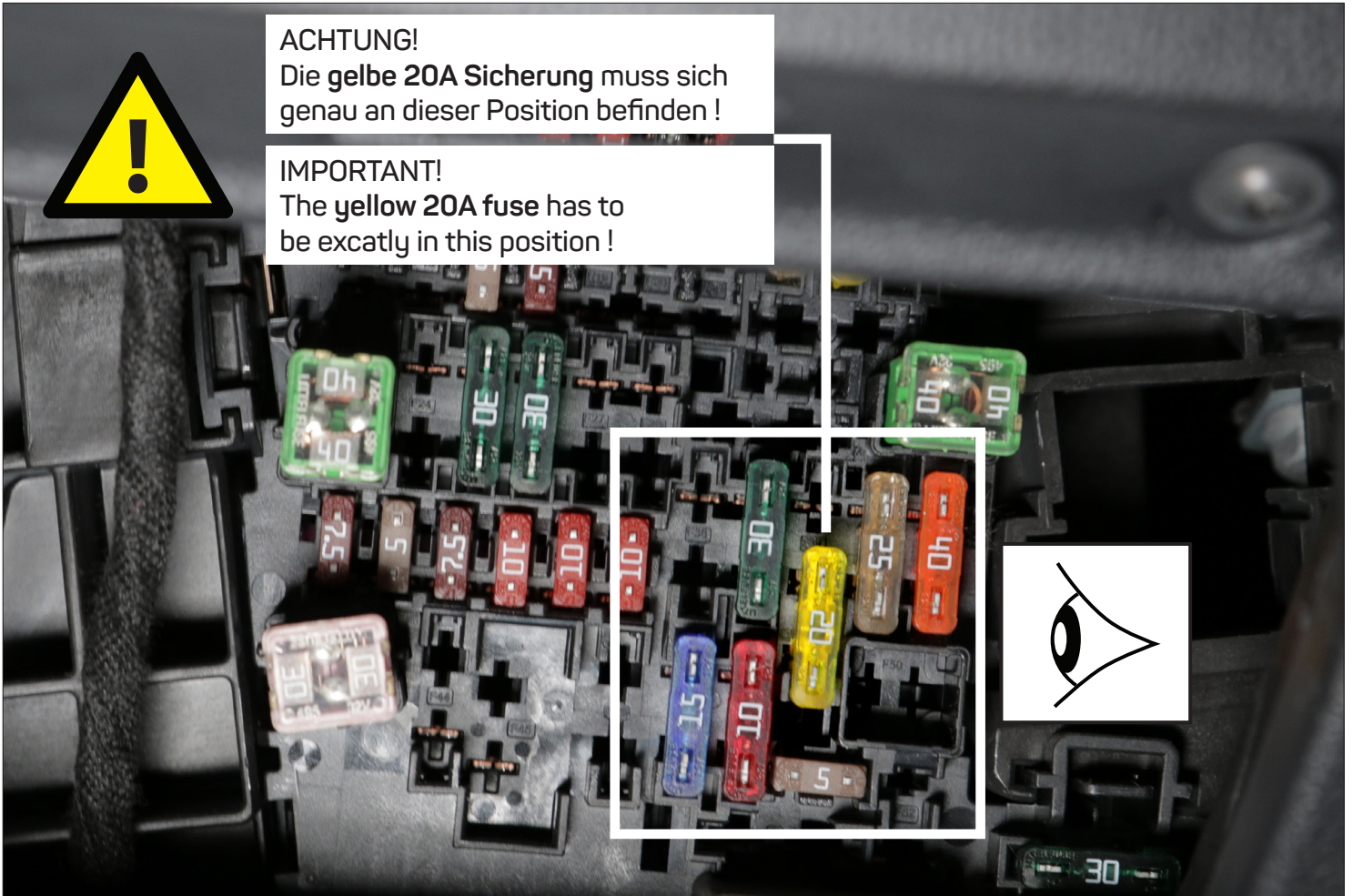

Falls sich die 20A Sicherung an einer anderen Position befinden sollte, stecken Sie diese um !

Switch the place of the 20A fuse if it is at this position !

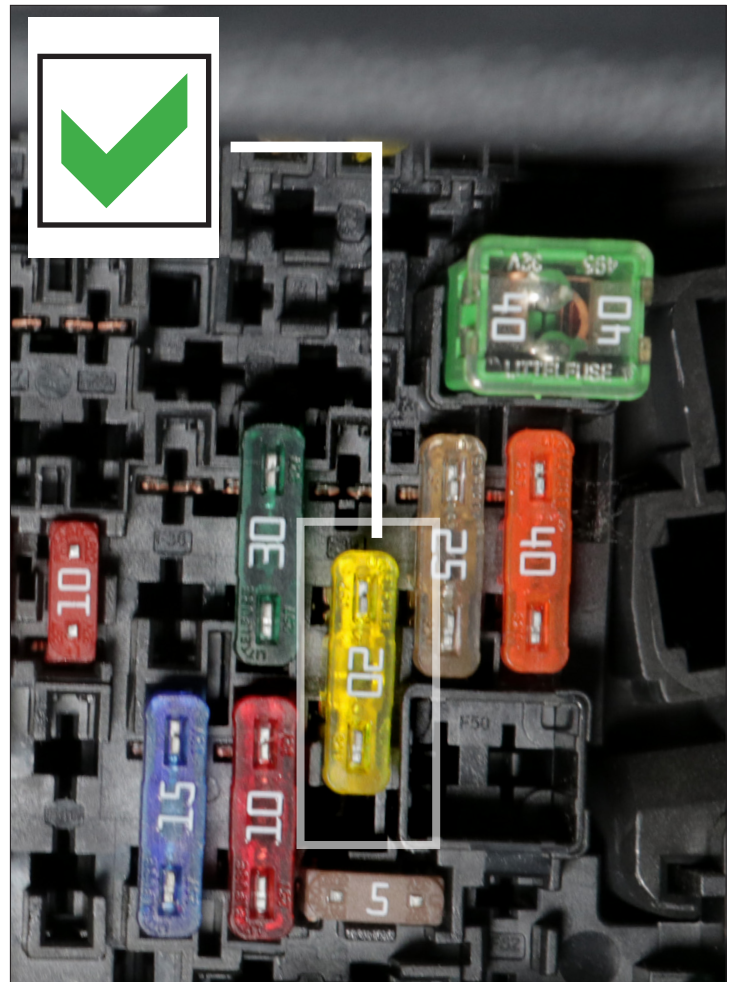

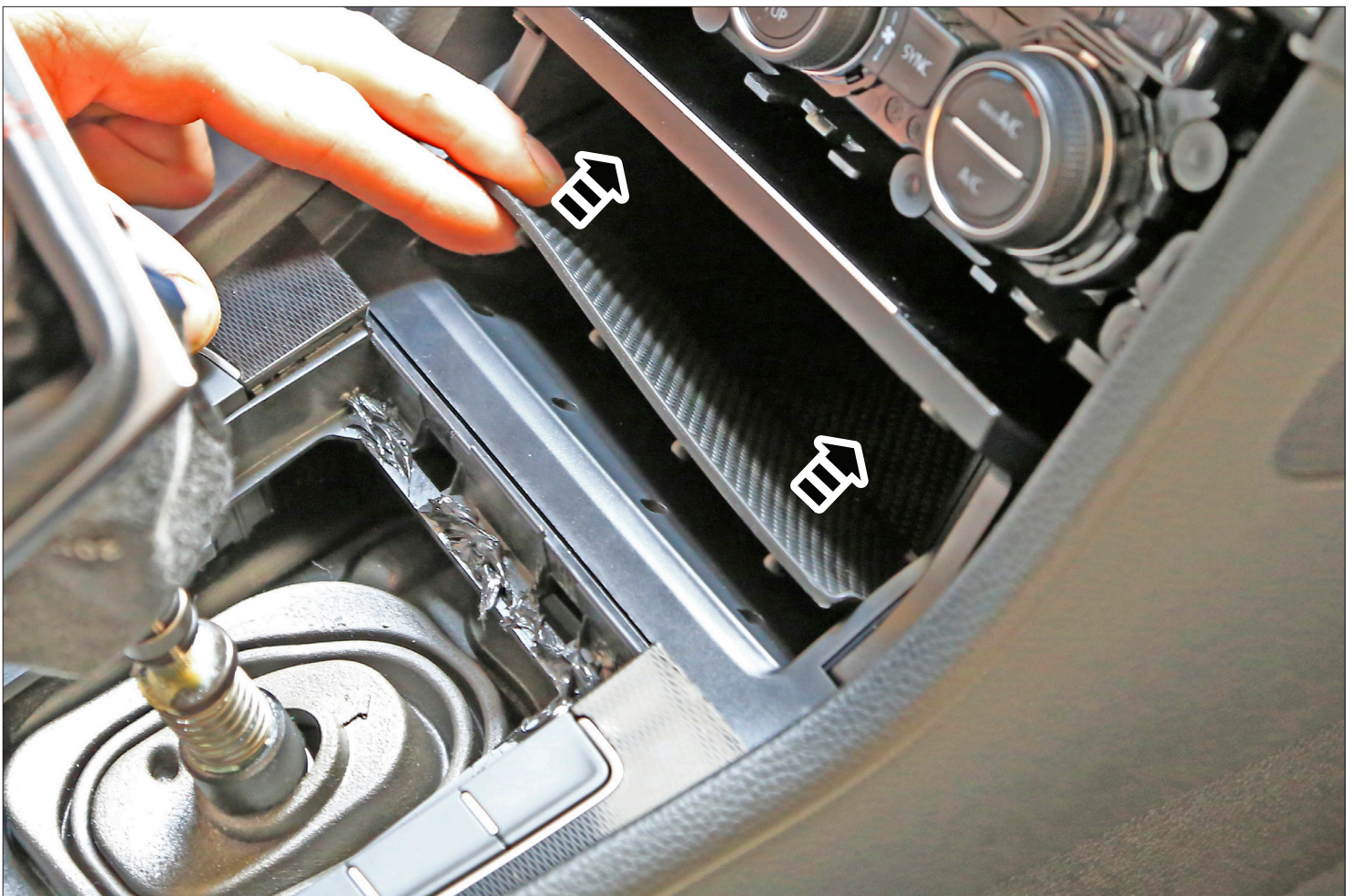

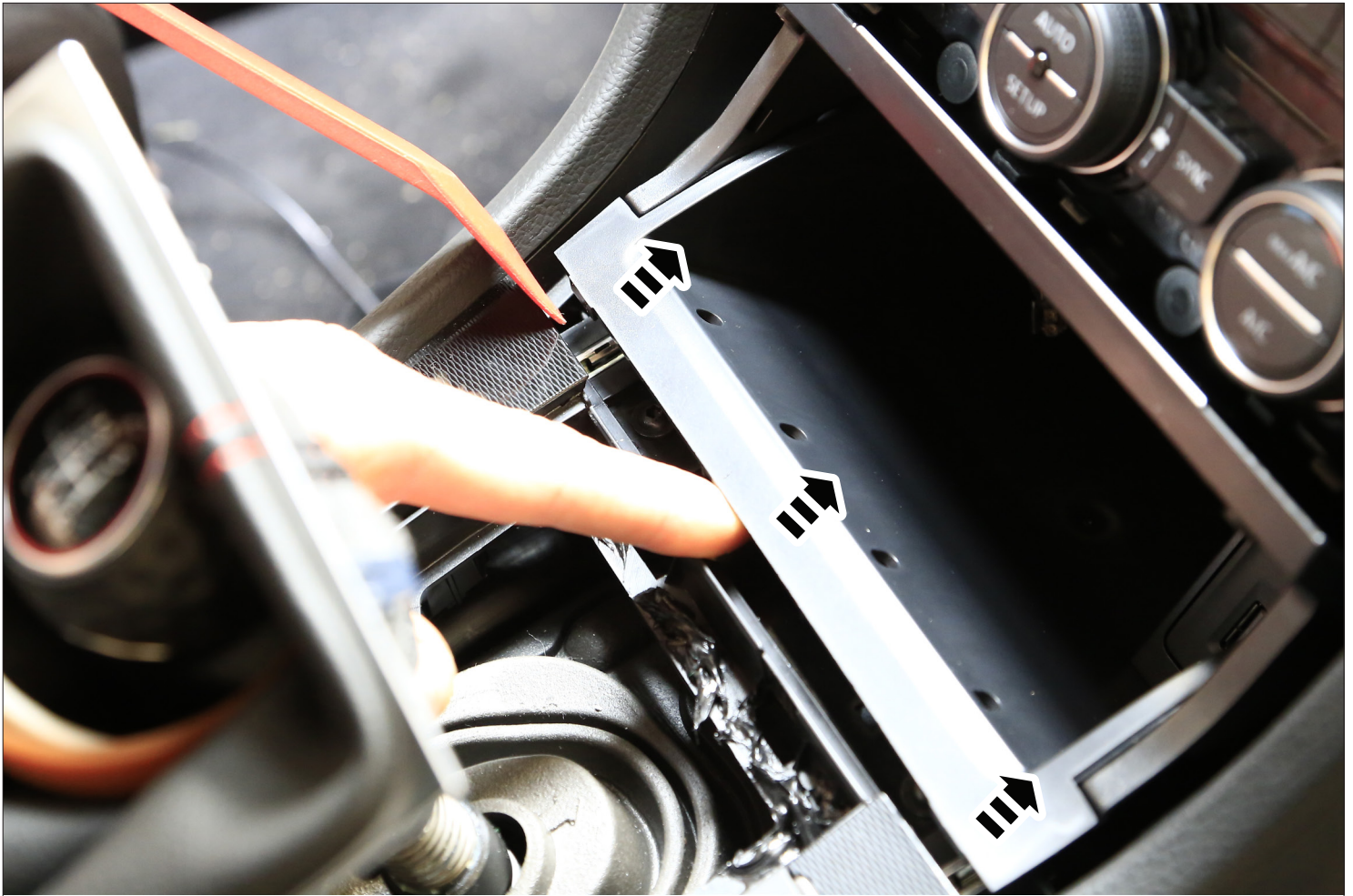

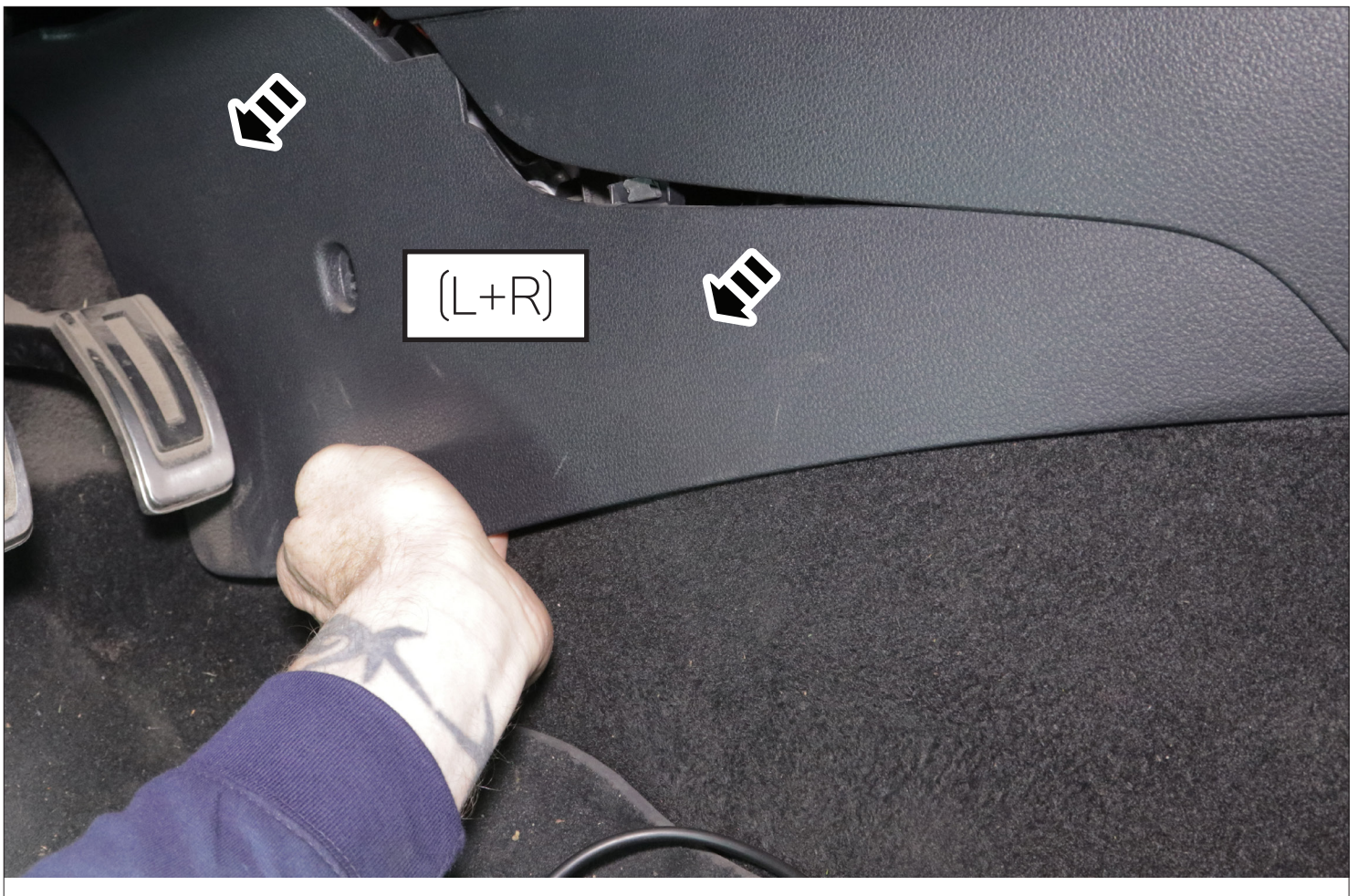



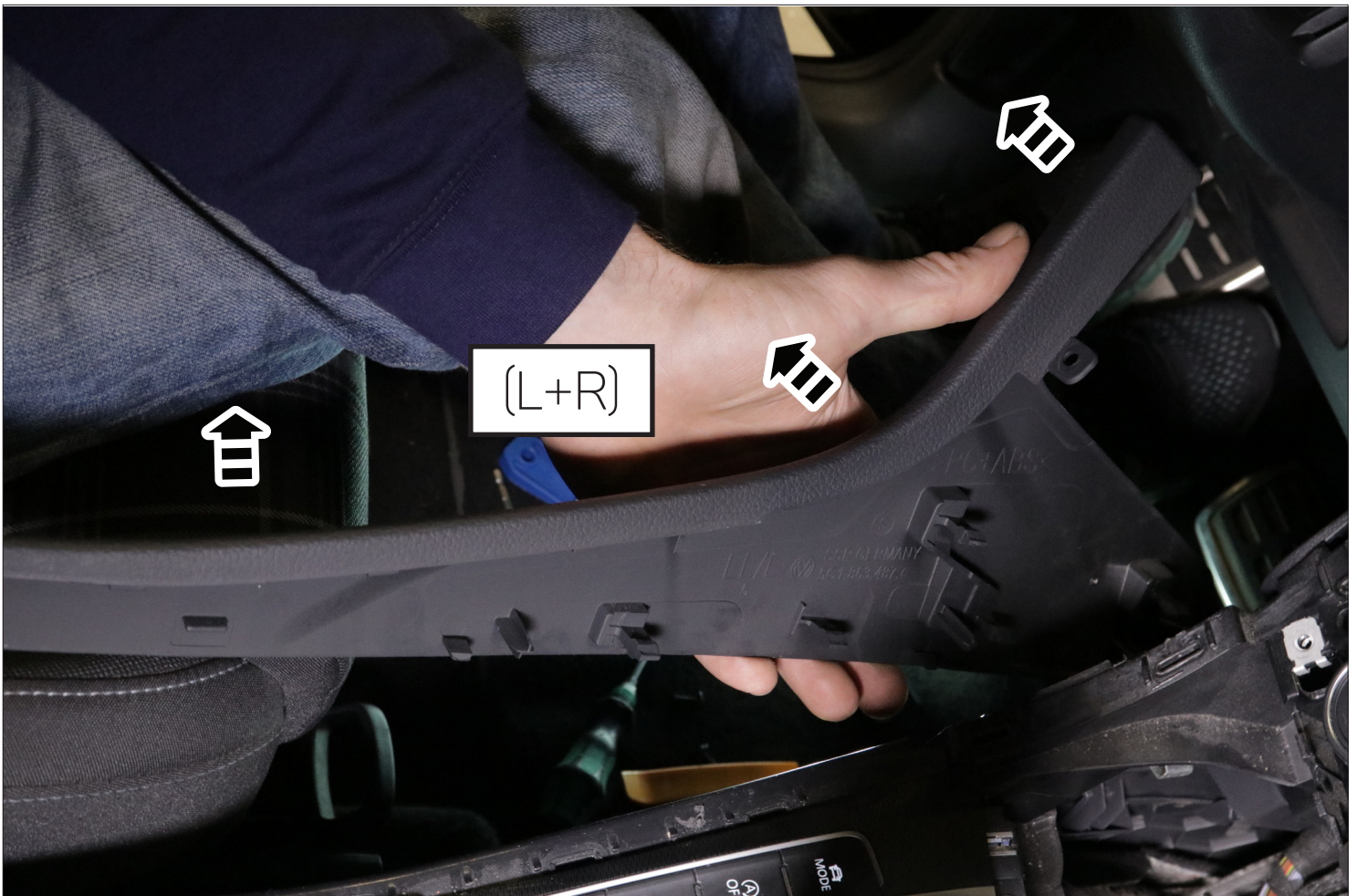







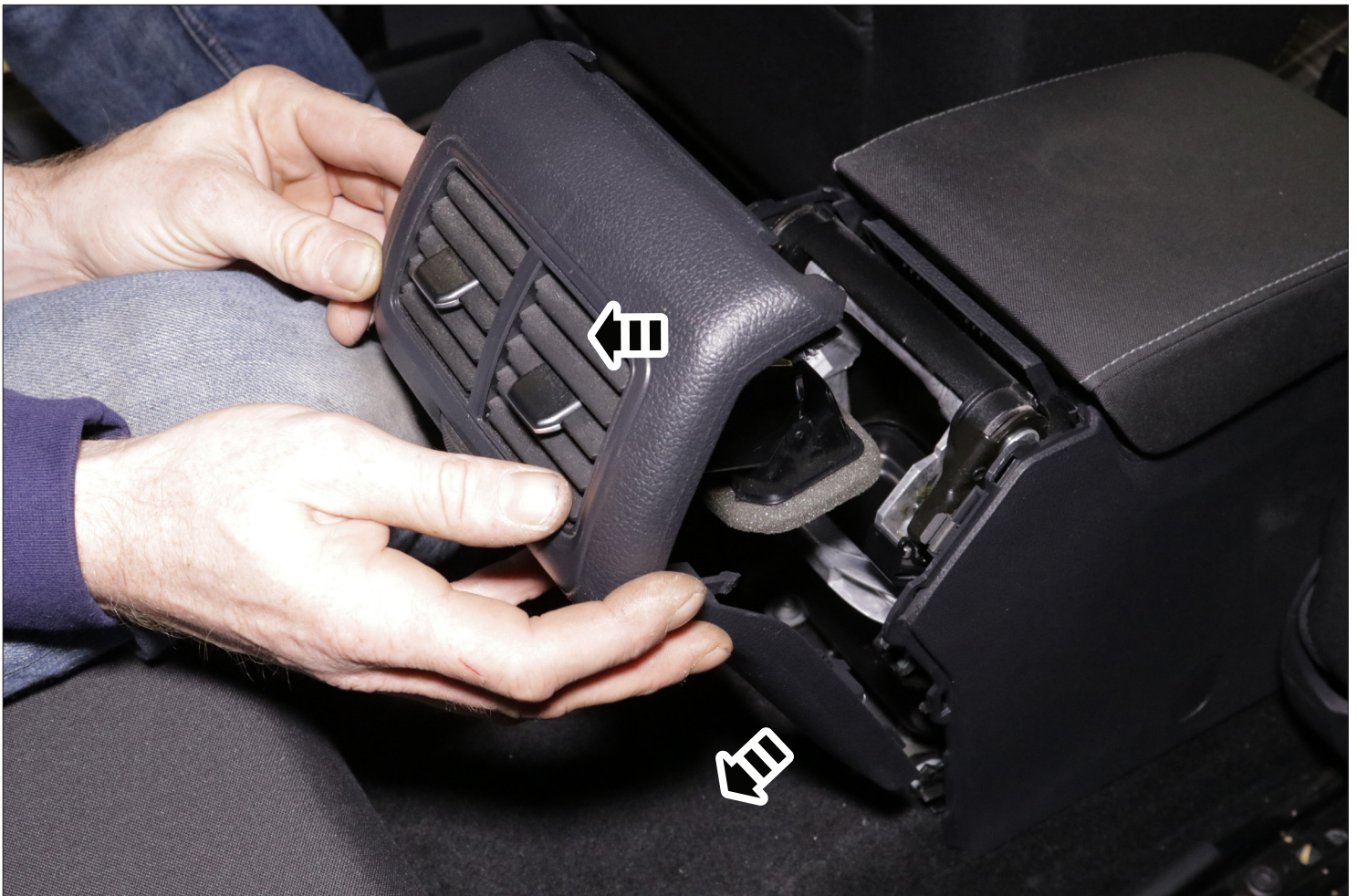
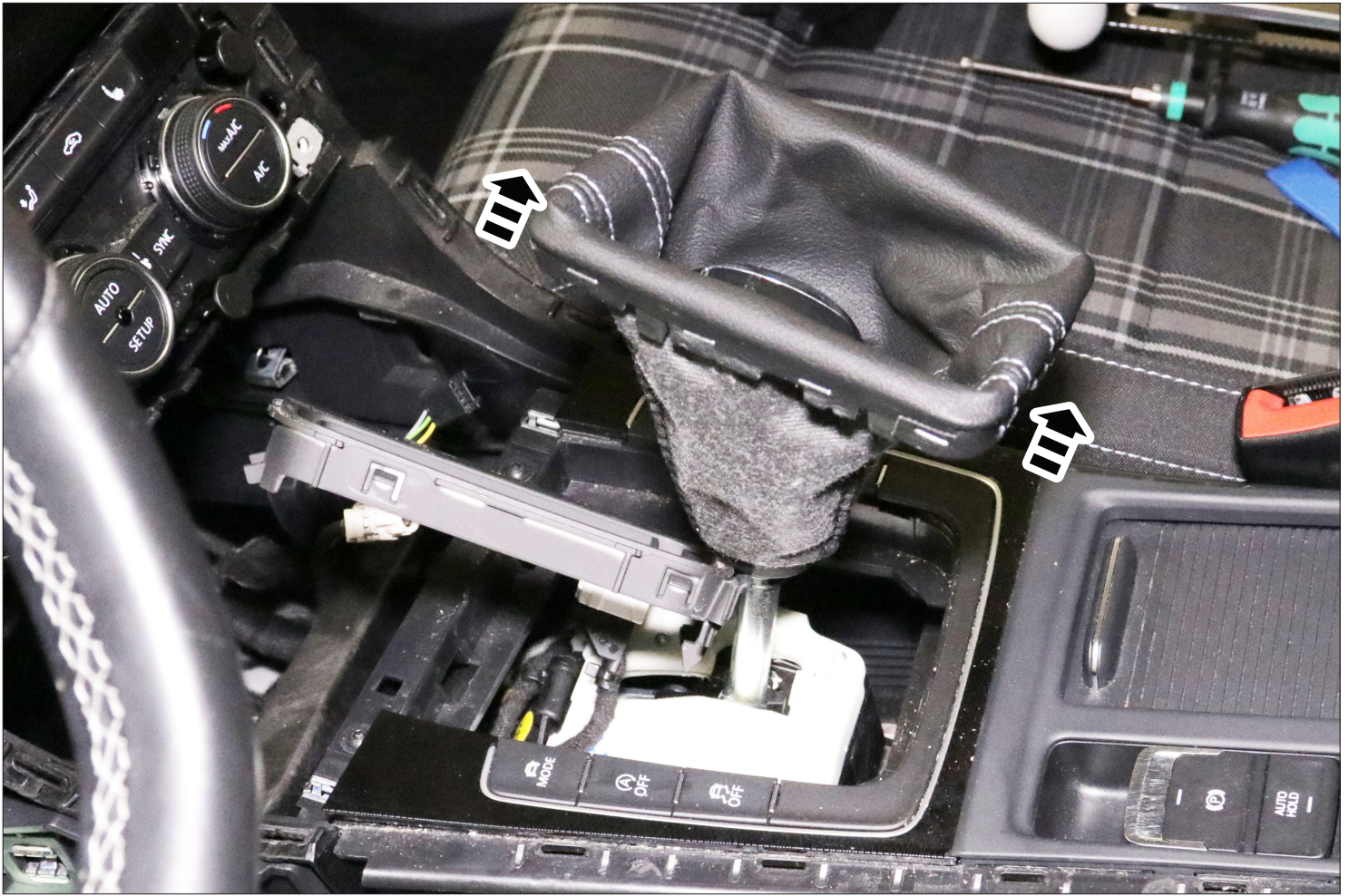

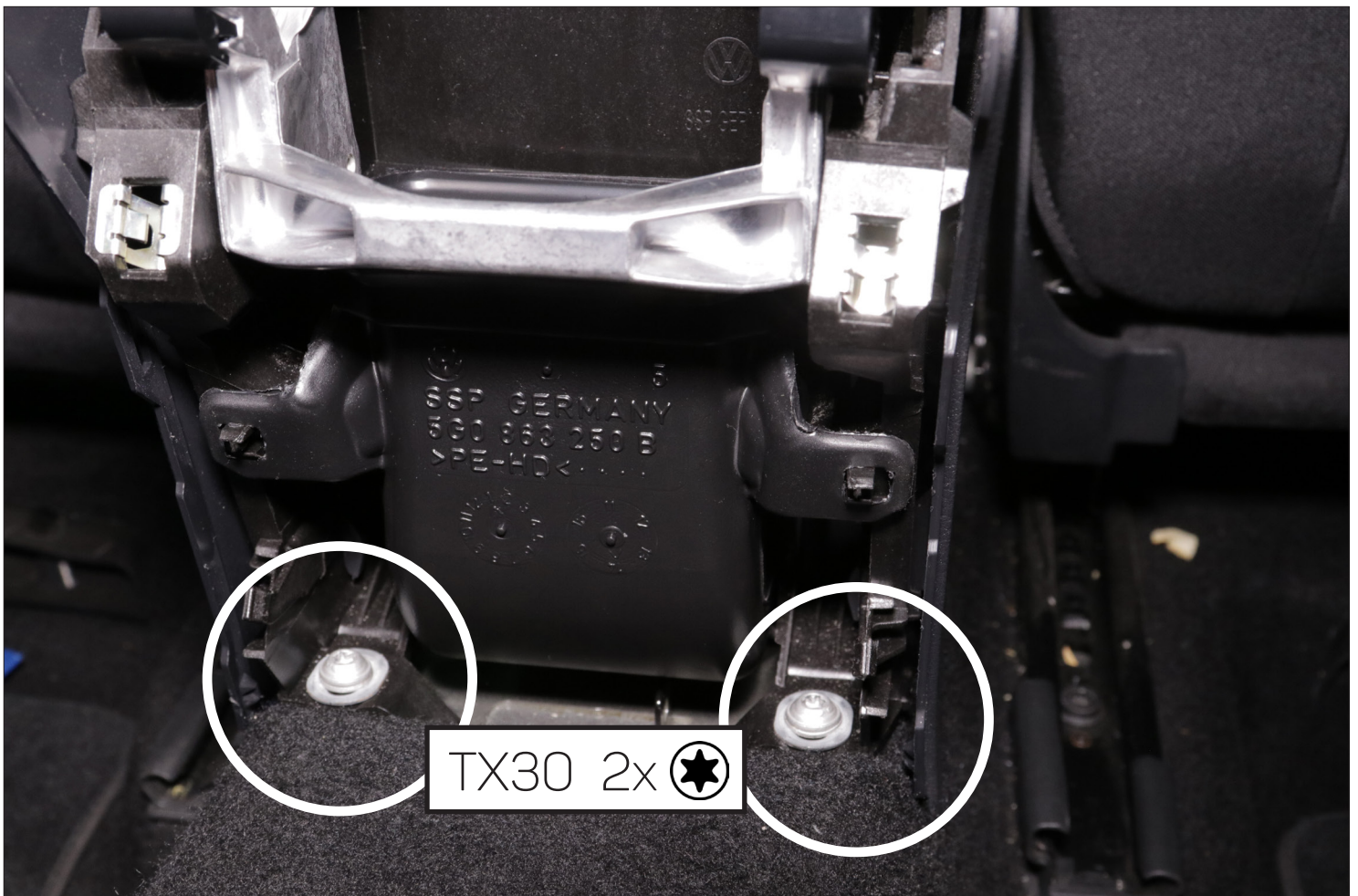

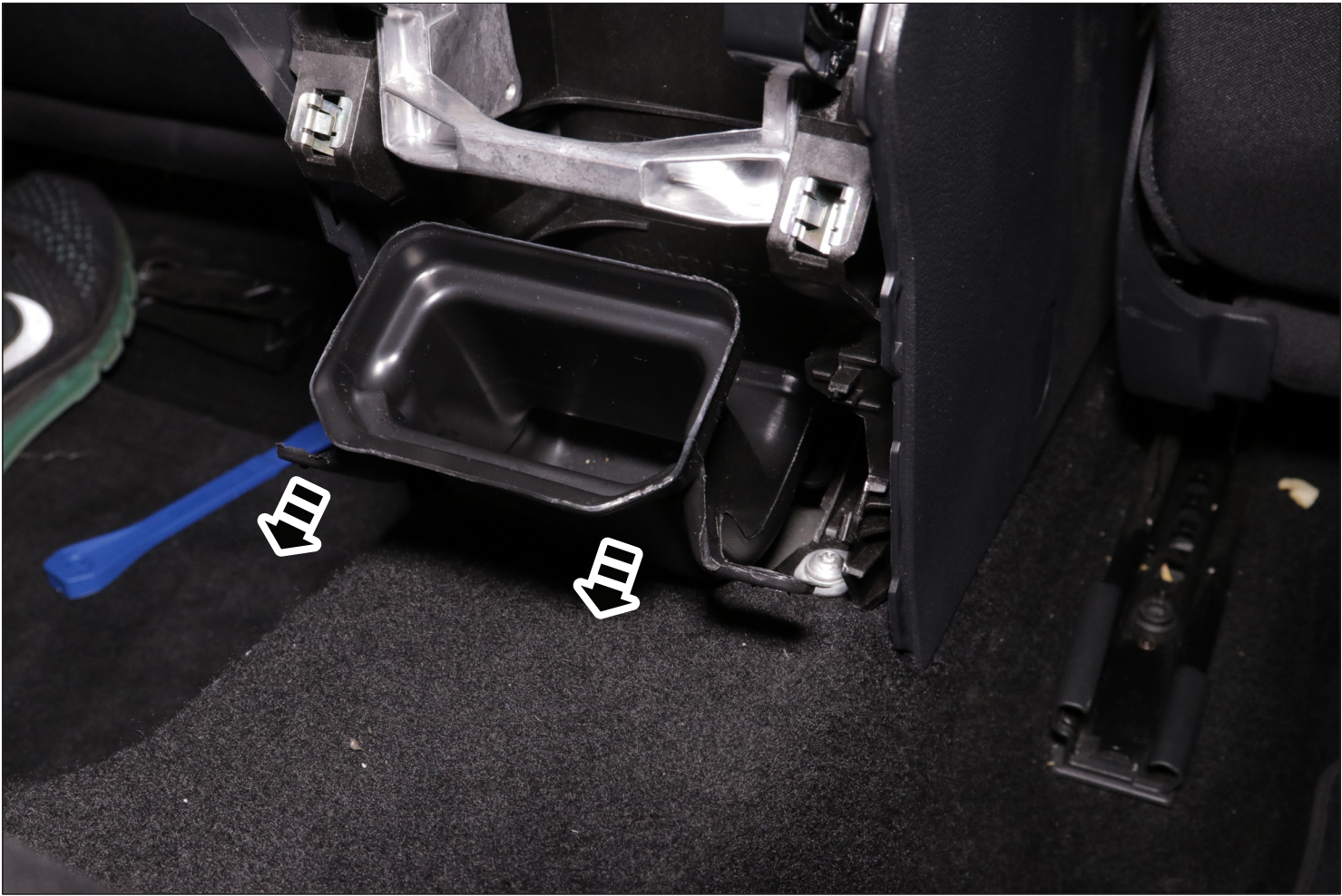

Ziehen Sie die gesamte Konsole nach oben (von hinten) und ziehen Sie den Stecker von der +12V Buchse ab.

Pull the complete panel upwards (from behind) and unplug the plug from the +12V Socket





